

This document describes **how to connect the device to the wireless network**. Check the access point or wireless router where the device will have to be connected and make sure that it is using **2.4GHz and b, g or n mode** for the wireless communication. For specific information about the wireless access point or router, please refer to their corresponding manuals. Make sure that the device is close enough to the wireless access point or router so there are no coverage issues.

**1** Install the device according to the instructions of the installation manual.

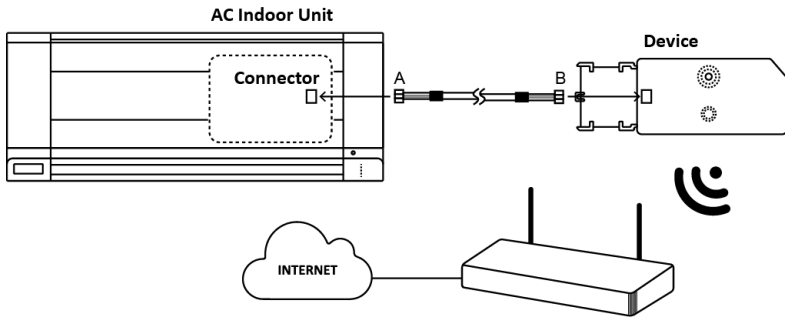

**2** Download the application from Google Play or App Store



Direct access to download links can be found at <https://www.intesis.com/accloud>

**3** Go to the wireless settings section of your smartphone or tablet\* and connect it to the network generated by your device (DEVICE\_xxxxxx or INTESISHOME\_xxxxxx).\*\*



**4** Tap on "Device Configuration" Button.\*\*\*

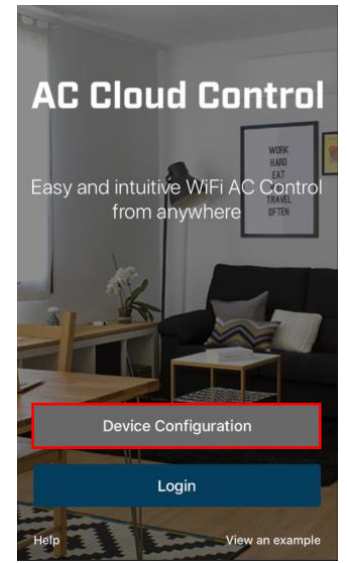

**5** Tap on "Next"

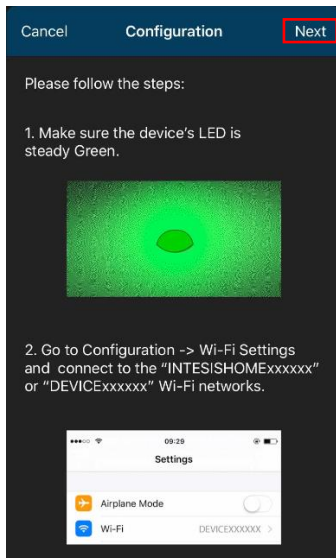

**6** Select "Automatic"

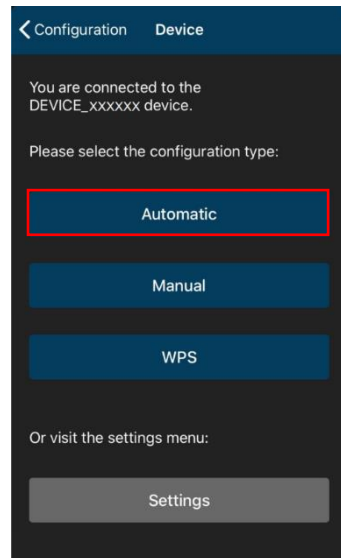

**7** Select the wireless network the device will be connecting to

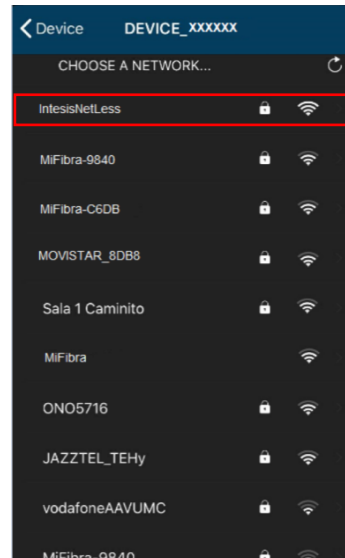

**8** Type the wireless network's password. Tap on "Connect"

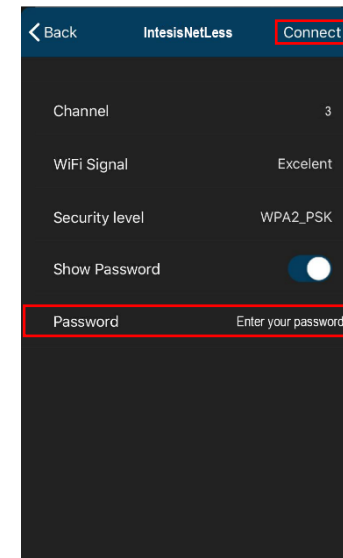

**9** Process completed \*\*\*\*

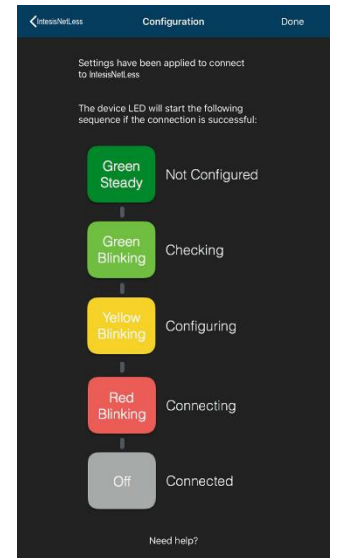

\*For further information about how to enable wireless network settings, please refer to smartphone or tablet manual.

\*\*If the network generated by your device is INTESISHOME\_xxxxxx please make sure the router is configured to allow b mode connections.

\*\*\* IMPORTANT: This view is only available if you are not logged into the account.

\*\*\*\* If the configuration process is not finished as expected, do the whole process again. If problem persist, contact our [support team](#).